

INSTALLERS DIAGRAM

MODEL NUMBER:1580VB-30-201-242-UM

UNDERMOUNT SINK

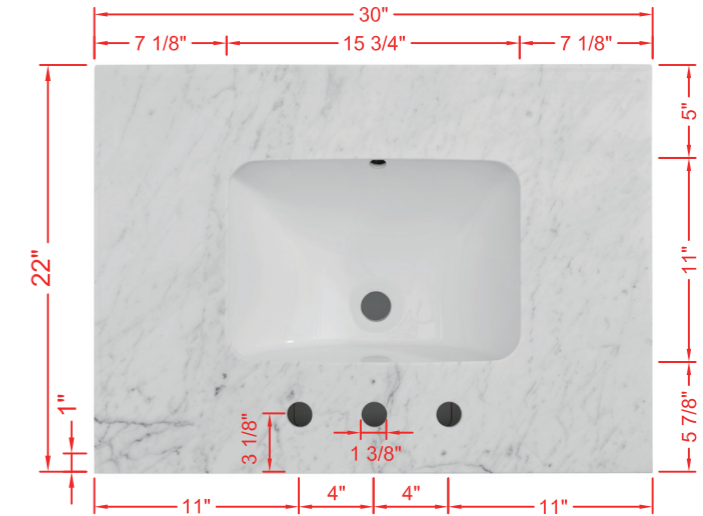
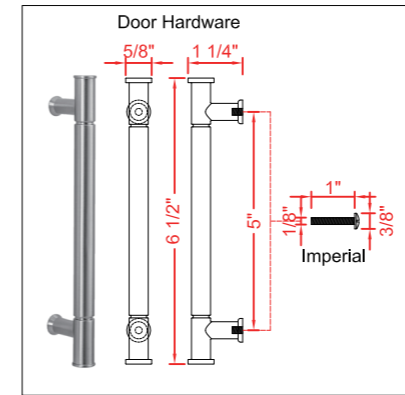
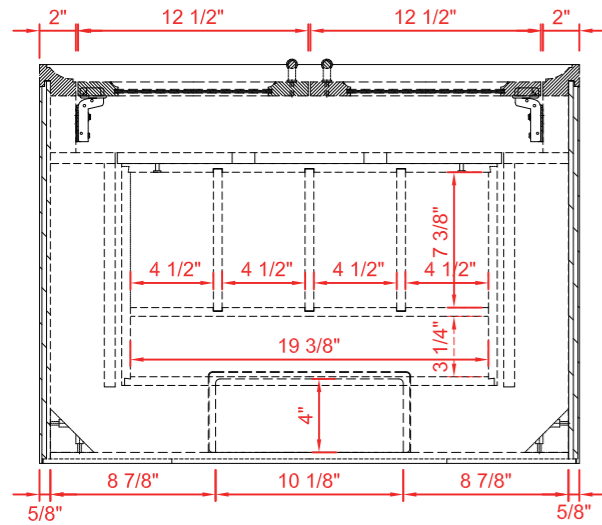

TOP VIEW

Product Net weight (W/O Top):77lbs.
Product packed Gross weight (W/O Top):110lbs.
Packed product Dimensions:
32.5in. W x 24.75in. D x 39.5in. H

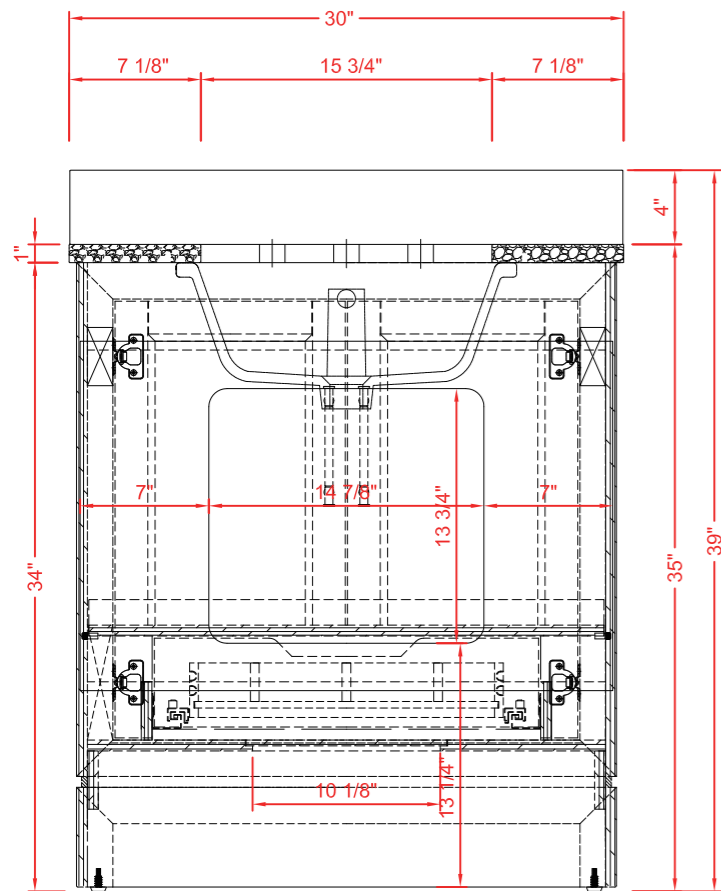

FRONT VIEW

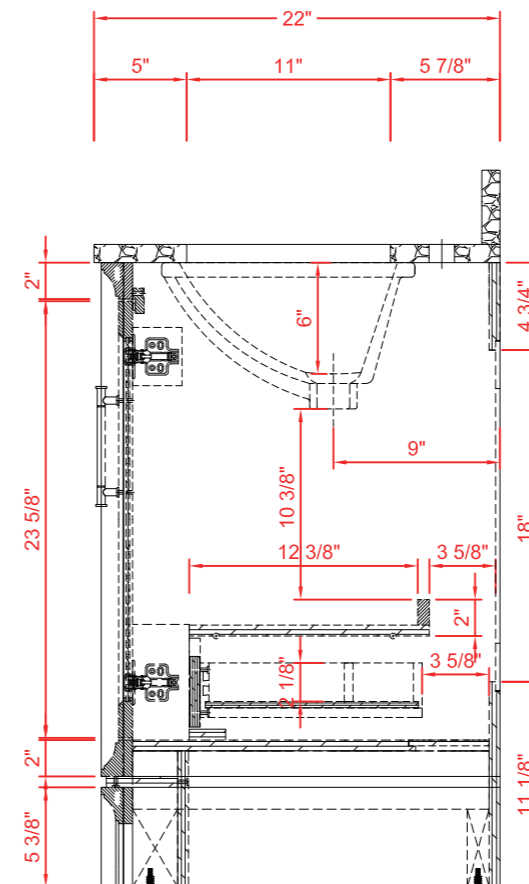

SIDE VIEW



INSTALLERS DIAGRAM

MODEL NUMBER:1580VB-30-201-242-SR

SEMI-RECESSED SINK

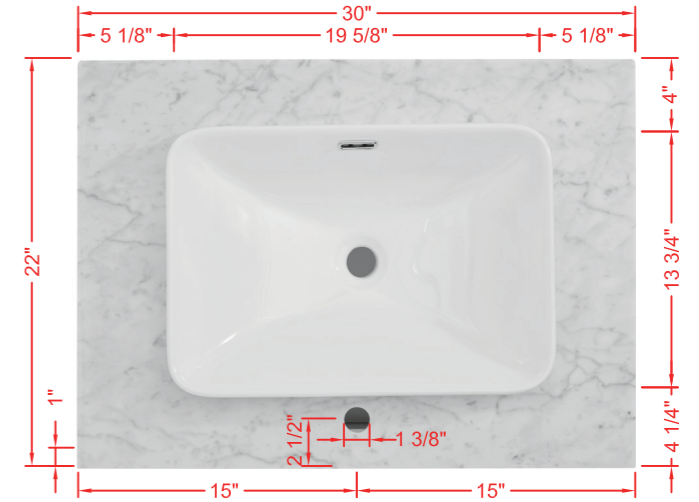
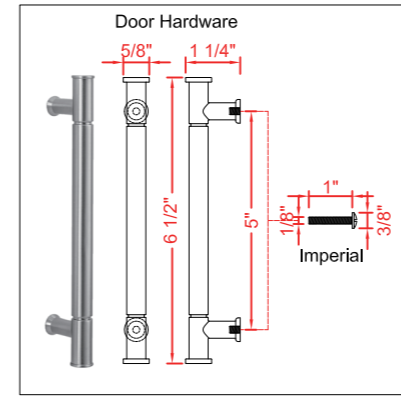
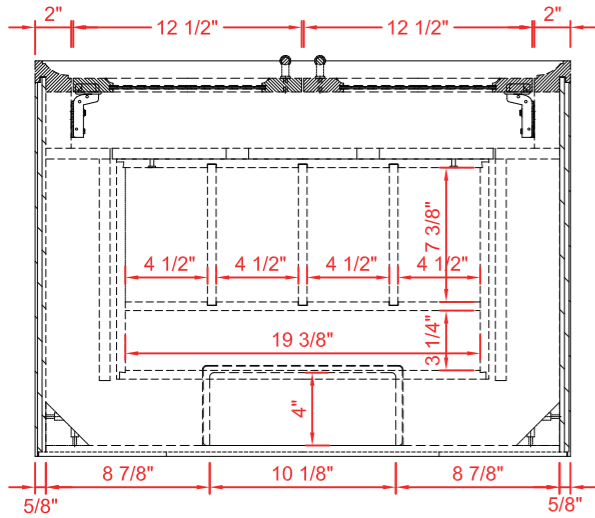

TOP VIEW

Product Net weight (W/O Top):77lbs.
 Product packed Gross weight (W/O Top):110lbs.
 Packed product Dimensions:
 32.5in. W x 24.75in. D x 39.5in. H

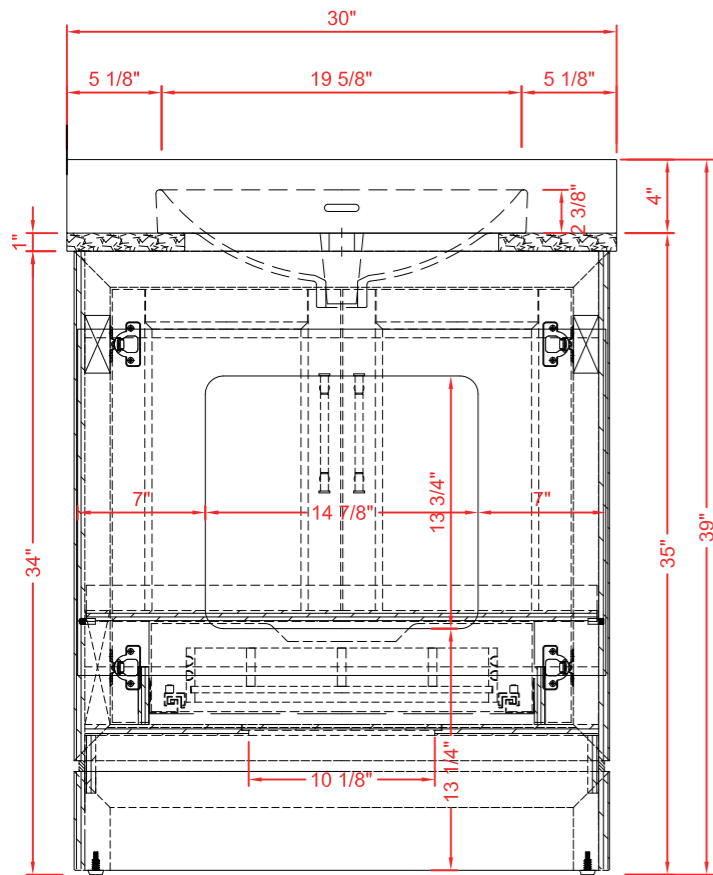

FRONT VIEW

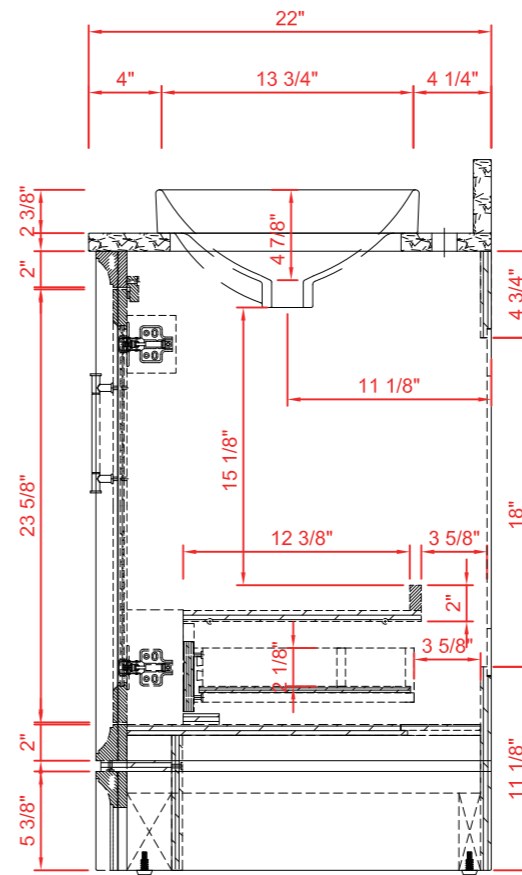

SIDE VIEW

